

ALC2 Architectural Linear Series

2.3" Linear Suspended Linear Run Luminaire

Fixture Type:

Project Name:

Location:

Date:

Features

- 2.3" wide achitectural linear luminaries is available in 2ft,3ft,4ft and 8ft.
- Simply provide wide, powerful lighting to any atmosphere with continuous runs.
- Extruded aluminum housing with preminum powder coat white or black finish.
- 100% downlight distribution
- Color temperature adjustable 3000K/3500K /4000K.
- Wattage selectable 100%/75%/50%
- Standard optical flat lens or Deep regressed lens
- Optional emergency battery backup is available.



Dimensions

DIMENSIONS

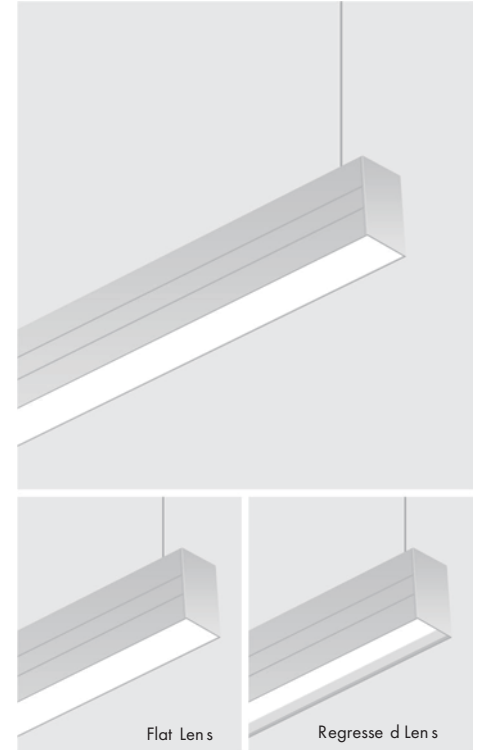
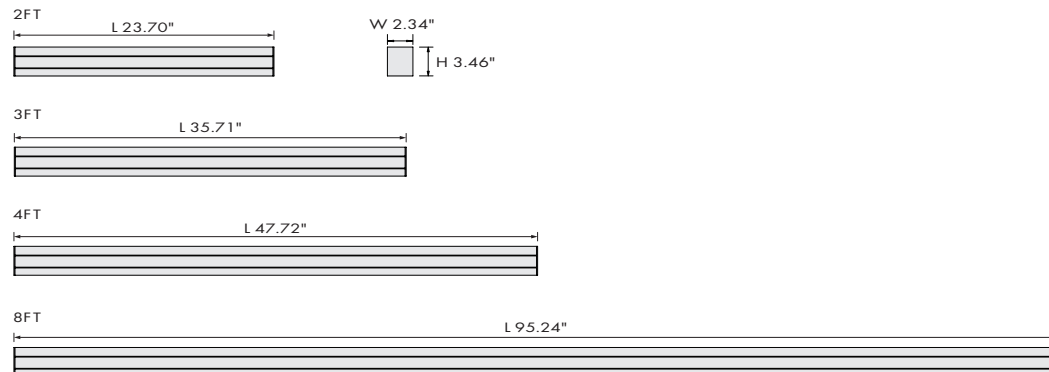

Specification

Material	Extruded aluminum housing	Efficacy	117lm/W
Lens	Flat/Deep regressed	LED Life Span	50,000 hrs
Beam angle	110 degree	Dimmable	0-10V Dimming
Color Temp	3CCT 3000K/3500K/4000K	Lumen Package	2,300 lm to 9,200lm
CRI	90	Warranty	5 Years
Input Voltage	120-277V	Ambient Operation Temperature	-20°C(-4°F) to 40°C (104°F)
Installation	Suspended mount	Listing	UL Listed Damp Location



ALC2 Architectural Linear Series

2.3" Linear Suspended Linear Run Luminaire

Fixture Type:

Project Name:

Location:

Date:

Ordering Guide

Example: ALC2-D-UW3CCT-WH-4

Fixture Type	Lens	Wattage	CCT	Finish	Linear Feet
ALC2	D =Flat lens(Default) R =Deep Regressed lens	UW =Wattage Selectable	3CCT =30/35/40K	WH = White BK = Black	Nominal linear feet = in increments of 4' fixture lengths come in 2'/3'/4'/8'

Optional Accessories

Emergency Battery Backup



EM

(SKU:EMBK8WH-A-EXT02)

=8W Emergency battery backup

Diffuser Lens Roll

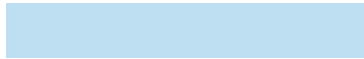

LR42

(SKU:ALC-LR42)

=42' LENS ROLL

Mounting Ceiling Type - Dry wall ceiling or Drop ceiling

Dry wall Ceiling Mount Individual Run

Example: AL-PDW-S-BK-kit

AL-PDW	Canopy Shape	Finish
Dry Wall Mounting Kit	R=Round S=Square	WH=Black BK=Black

Notes:

Dry wall ceiling mounts kit will consist of:

1 pc - 4" round or square canopy for power feed side,

1 pc - 4" round or square canopy for non power feed side,

1 pc - 2" round or square canopy for non power feed side,

1 pc - J-box cross bar, 1 pc - 5FT Power feed, 1 set - 5ft aircraft Cable.

Dry wall Ceiling Mount Continued Run

Example: AL-PDW-S-BK, AL-NDWCNP-S-BK-2, ALB-FC

AL-PDW	Canopy Shape	Finish	
Dry Wall Mounting Kit	R=Round S=Square	WH=White BK=Black	
AL-NDWCNP	Canopy Shape	Finish	Canopy Size
Canopy for continued run non-power feed	R=Round S=Square	WH=White BK=Black	2=2inch 4=4inch

Linear Run connector



ALC-FC = Inline connector



ALC2 Architectural Linear Series

2.3" Linear Suspended Linear Run Luminaire

Fixture Type:

Project Name:

Location:

Date:

Drop Ceiling Mount Individual Run **Example: AL-PTB-R-9-F-WH-KIT**

	Canopy Shape	Grid Size	Grid Type	Finish
AL-PTB				
Drop ceiling mounting kit	R=Round S=Square	9=9/16 15=15/16	F=Flat S=Slot	WH=Blank BK=Black

- Notes:
 Drop ceiling mounts kit will consist of:
 1 pc - 4" round or square canopy for power feed side,
 1 pc - 4" octagon junction box
 1 pc - 4" round or square canopy for non power feed side,
 1 pc - 2" round or square canopy for non power feed side,
 1 set - T-grid clips for both power feed and non power feed,
 1 pc - 5FT Power feed,
 1 set - 5ft aircraft Cable.

Drop Ceiling Mount Continued Run **Example: AL-PTB-R-9-F-WH,AL-NTBCNP-R-9-F-WH-2,ALB-FC**

Power feed	Canopy Shape	Grid Size	Grid Type	Finish
AL-PTB				
Drop ceiling mount	R=Round S=Square	9=9/16 15=15/16	F=Flat S=Slot	WH=Blank BK=Black

Non-Power feed	Canopy Shape	Grid Size	Grid Type	Finish	Canopy Size
AL-NTBCNP					
Drop ceiling mount	R=Round	9=9/16	F=Flat	WH=Blank	4=4inch
Non-Power feed side	S=Square	15=15/16	S=Slot	BK=Black	2=2inch

Linear Run connector



ALC-FC = Inline connector

ALC2 Architectural Linear Series

2.3" Linear Suspended Linear Run Luminaire

Fixture Type:

Project Name:

Location:

Date:

Mounting

Dry Wall Mount

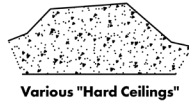
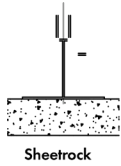

Drop Ceiling / Off Grid

Compatible for various T grid

- 9/16" Flat
- 15/16" Flat
- 9/16" Slot
- 15/16" Slot

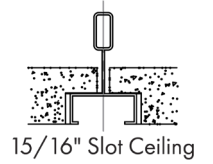
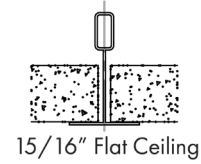
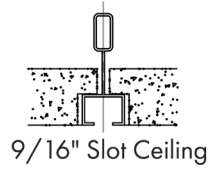
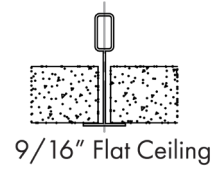

Pendant Accessories For Dry Ceiling

Canopy Kits



Pendant Accessories For Drop Ceiling

Canopy Kits



Junction Box



Power Cord Kits



5FT Standard
(12FT Available)

Power Cord Kits



Aircraft Cable Kits



Aircraft Cable Kits



5FT Standard
(12FT Available)

T-grid Clips





ALC2 Architectural Linear Series

2.3" Linear Suspended Linear Run Luminaire

Fixture Type:
Project Name:
Location:
Date:

Performance Data:

Lens	High	Medium	Low
Flat	1,000lm/ft, 10w/ft	750lm/ft, 7.5w/ft	500lm/ft, 5w/ft
Deep Regressed	800lm/ft, 10w/ft	600lm/ft, 7.5w/ft	400lm/ft, 5w/ft

ALC Architectural Linear Series

2.3" Linear Suspended Linear Run Luminaire

Fixture Type:

Project Name:

Location:

Date:

Line Connection:

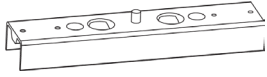

Linear Connector
(-ALC-FC)

120Vac: Connections up to 40ft
277Vac: Connections up to 100ft

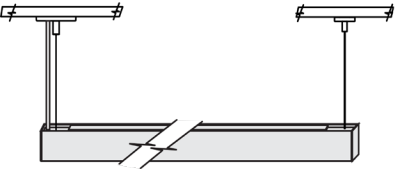

Mounting point:
24.72" for 2FT fixture
49.8" for 4FT fixture
100.08" for 8FT fixture

Continuous Run

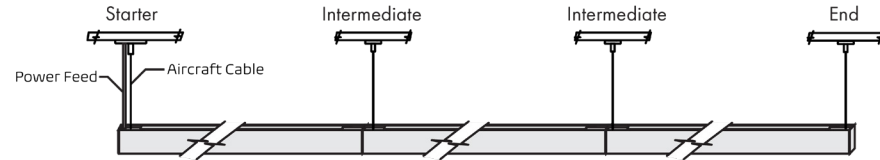

Mounting point:
24.96" for 2FT fixture
50.04" for 4FT fixture
100.2" for 8FT fixture

Mounting point:
25.08" for 2FT fixture
50.28" for 4FT fixture
100.44" for 8FT fixture

Mounting point:
24.96" for 2FT fixture
50.04" for 4FT fixture
100.2" for 8FT fixture

Luminaire Run Length (ft)	Run Configuration	Line Joinder	5' Power Cable	5' Aircraft Cable	Canopy
2	2'	-	1	2	2
4	4'	-	1	2	2
6	4'+2'	1	1	3	3
8	8'	-	1	2	2
10	8'+2'	1	1	3	3
12	8'+4'	1	1	3	3
14	8'+4'+2'	2	1	4	4
16	8'+8'	1	1	3	3
18	8'+8'+2'	2	1	4	4
20	8'+8'+4'	2	1	4	4
22	8'+8'+4'+2'	3	1	5	5
24	8'+8'+8'	2	1	4	4
26	8'+8'+8'+2'	3	1	5	5
28	8'+8'+8'+4'	3	1	5	5
30	8'+8'+8'+4'+2'	4	1	6	6
32	8'+8'+8'+8'	3	1	5	5
34	8'+8'+8'+8'+2'	4	1	6	6
36	8'+8'+8'+8'+4'	4	1	6	6
38	8'+8'+8'+8'+4'+2'	5	1	7	7
40	8'+8'+8'+8'+8'	4	1	6	6
42	8'+8'+8'+8'+8'+2'	5	2	7	7

ALC2 Architectural Linear Series

2.3" Linear Suspended Linear Run Luminaire

Fixture Type:

Project Name:

Location:

Date:

Optional Accessories

Emergency Battery Backup:



8W Emergency Battery Backup

SKU: EMBK8WH-A-EXT02

- Field install only .
- 8W emergency battery provided up to 680 lumen during the emergency mode.