

EMJB-13W03 Series

EMERGENCY BATTERY BACKUP 13W

Fixture Type:

Project Name

Location:

Date:

Features

- 13W J-BOX Emergency Battery Backup.
- Easy and quick installation.
- Compatible with CSP-BU and DD4-BU
- UL Listed.
- 5 Years Warranty.



Dimension

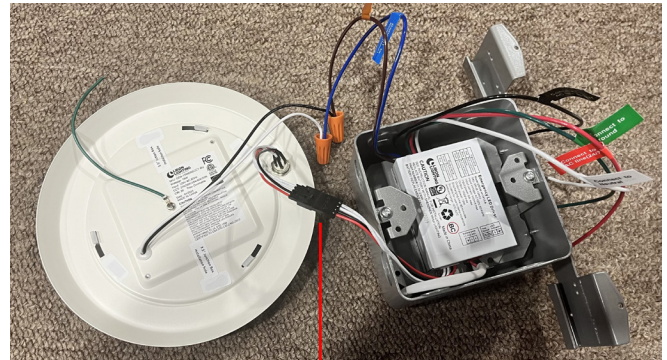
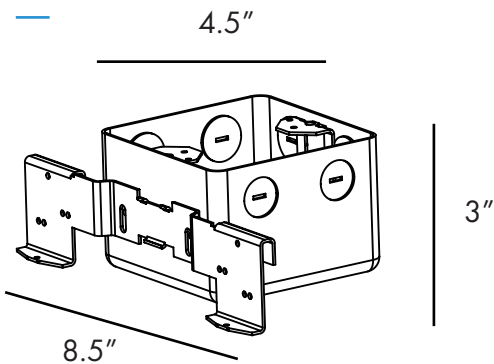

Quick-connect feature for the test button ensures easy and fast installation.

DD4-BU is come with quick connect feature.

Wiring Diagram

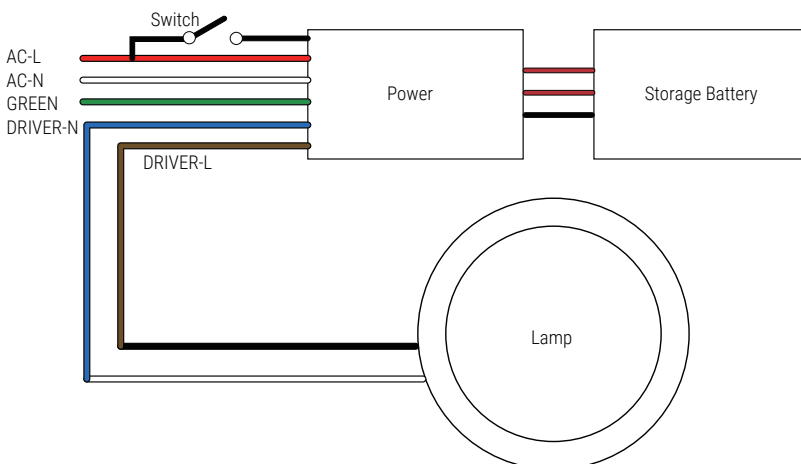

EMJB-13W03 Series

EMERGENCY BATTERY BACKUP 13W

Fixture Type:

Project Name

Location:

Date:

INSTALLATION INSTRUCTIONS

SAFETY PRECAUTIONS

For safety, read and understand instructions completely before starting installation. Electricity should be turned off at the fuse or the circuit breaker box before installing the fixture. All electrical connections must be in accordance with N. E. C. or your local code.

ASSEMBLY INSTRUCTIONS

1. Preparing for installation
Disconnect electrical power before installing or servicing any part of this fixture.
2. This product SHALL be surface mounted with junction box or non-combustible surface above 4 feet (1.2 meter) high. User should prepare necessary accessories and spare parts (not provided) including junction box and screws.

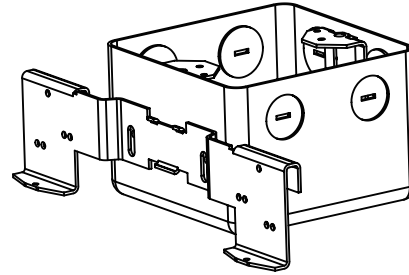

CONSULT A QUALIFIED ELECTRICIAN BEFORE INSTALLING

Step 1: Install the emergency power supply onto the beam and secure it with screws. See, Fig A.

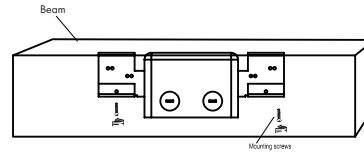

Fig A

Step 2: Turn off/disconnect the power supply of the circuit breaker. Connect the three wires of the emergency power supply to the household electricity, and fix the connected wires in the emergency power box. See, Fig B.

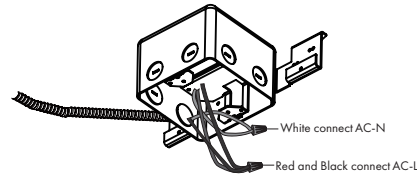

Fig B

Step 3: Connect the power cord to the wire of the disk light using a screw. Connect Brown to black and blue to white. See, Fig C.

Step 4: Arrange the wires into the junction box. Align the appropriate slot on the disk light with the hole on the junction box. Fix the disk light with 2 screws, flush with the ceiling. See, Fig D.

Step 5: Rotate counterclockwise to return the lens to its original position. See, Fig E.

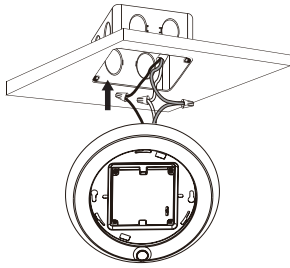

Fig CF

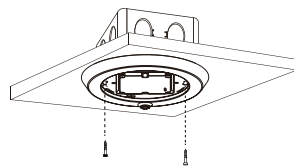

Fig D

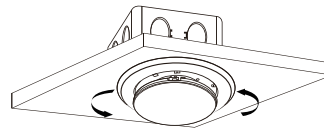

Fig E

OPERATION

Ac power supply is available. The AC driver operates the LED load as designed. Emergency power is charged in standby mode. A blinking red light indicates that the battery is being charged.

When the AC power supply is off, the emergency power supply detects that the AC power supply is interrupted and automatically switches to the emergency mode. The red light is off. After the AC power is restored, the emergency power switches to the AC power and starts charging. The red light flashes. If the indicator is steady red, the battery is fully charged.

CAUTION: RISK OF ELECTRIC SHOCK
DISCONNECT POWER BEFORE CONNECTING THE FIXTURE.
FAIL TO DO SO MAY PERMANENTLY DAMAGE THE LEDS.

WARNING:
DO NOT REMOVE OR ATTEMPT TO REMOVE LEDS.