

Square Tapered Steel Poles

Part Number	Mounting Height (ft.)	Effective Projected Area (sq. ft.)				Shaft Dimensions			Base Information		Ship Weight (lb.)
		80	90	100	120	Butt O.D.	Top O.D.	Wall Thickness (ga.)	Anchor Bolt Dia. (in.)	Bolt Circle (in.)	
STP-20-5211	20	14.4	11.6	9.4	6.6	5.25	3.25	11	1	10.0	204
STP-25-6211	25	13.1	10.6	8.5	6.0	6.25	3.75	11	1	12.5	294
STP-30-6211	30	8.9	7.2	5.8	4.0	6.25	3.25	11	1	12.5	310
STP-35-6611	35	6.7	5.5	4.4	3.1	6.65	3.25	11	1	12.5	362
STP-39-7111	39	5.9	4.8	3.8	2.7	7.15	3.25	11	1	12.5	414

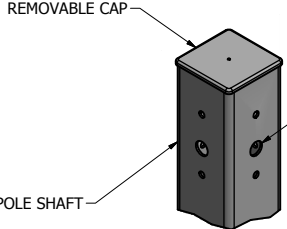

REMOVABLE CAP
POLE SHAFT

DRILLED PER FIXTURE REQUIREMENTS:
D1- DRILLED FOR 1 FIXTURE
D2- DRILLED FOR 2 FIXTURES AT 90° OR 180°
D3- DRILLED FOR 3 FIXTURES
D4- DRILLED FOR 4 FIXTURES

DRILLED MOUNT OPTIONS

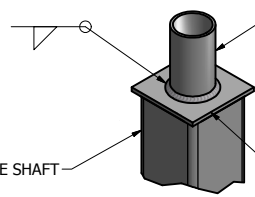

TENON MOUNT OPTIONS:
T2- Ø2.38 OD X 4.00 LG
T2.5- Ø2.88 OD X 4.00 LG
T3- Ø3.00 OD X 5.00 LG
T4- Ø4.00 OD X 6.00 LG

POLE SHAFT
.25 THK TENON MOUNT

TENON MOUNT OPTIONS

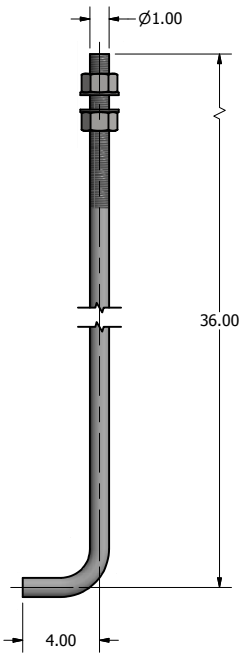

Ø1.00 X 40.00 ANCHOR BOLT

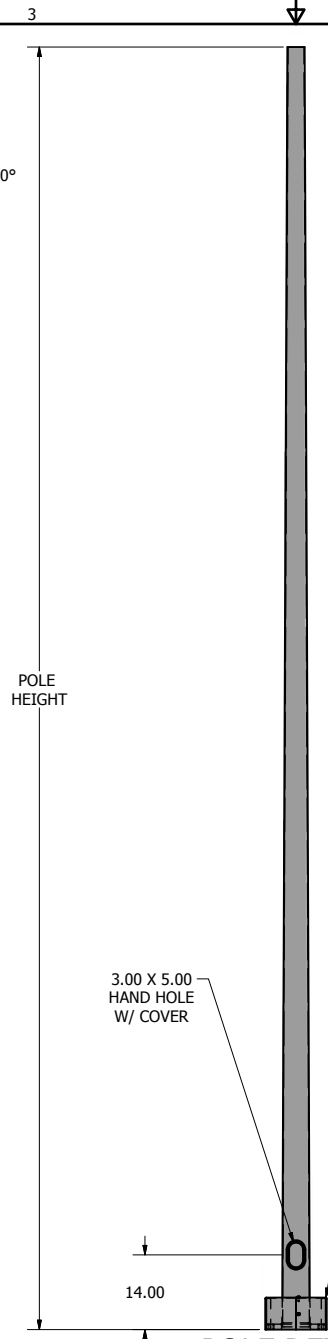

POLE DETAIL

POLE SPECIFICATIONS			
NO.	COMPONENT	ASTM DESIGNATION	MIN. YIELD (P.S.I)
1.	POLE SHAFT	A-595 GR. A	55,000
2.	BASE PLATE	A36	36,000
3.	ANCHOR BOLTS	F1554 GR. 55	55,000
4.	GALVANIZED HARDWARE	A153	-
FINISH SPECIFICATIONS			
POLES SHALL HAVE A POLYESTER POWDER COAT FINISH IN A STANDARD COLOR.			
POLE DIMENSIONS			
POLE HGT (FT.)	TOP SQ. SIZE (IN.)	BOT. SQ. SIZE (IN.)	GAGE
20'	3.25	5.25	11 GAGE
BASE PLATE DIMENSIONS			
BOLT CIRCLE (IN.)	BASE PLATE DIM. (IN.)	BOLT HOLE (IN.)	PLATE THK. (IN.)
9.50-10.50	11.00 SQ.	1.25	1.00
ANCHOR BOLT DIMENSIONS			
ANCHOR BOLT DIA. (IN.)		ANCHOR BOLT LENGTH (IN.)	
1.00		40.00	
ALLOWABLE WIND LOADING (SQ. FT.)			
WIND*	INDICATED EPA	80 MPH	90 MPH
EPA	-	14.4	11.6
		100 MPH	120 MPH
		9.4	6.6

*WITH 1.3 GUST FACTOR

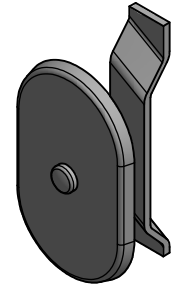

3.00 X 5.00 HAND HOLE COVER

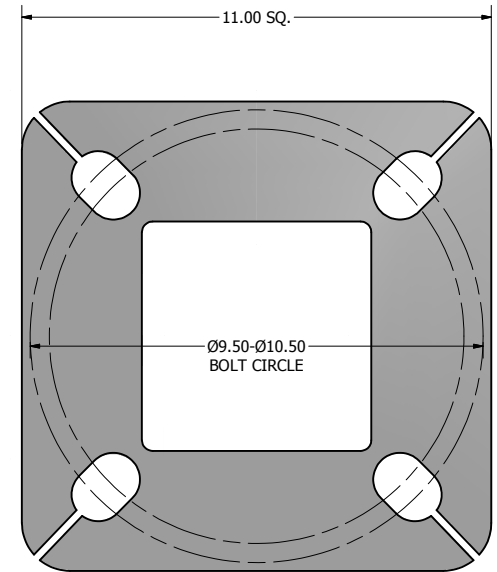

11.00 X 11.00 X 1.00 BASE PLATE

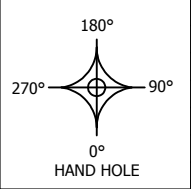

DRAWN: M. HARVALA	6/8/2015
CHECKED:	
REVISION:	DATE:
APPROVED:	
QUOTE:	
S.O.#	
REF:	SCALE: NONE



SOME GEOGRAPHICAL AREAS HAVE SPECIAL WIND CONDITIONS THAT CAN CREATE WIND INDUCED VIBRATIONS CAUSING A FATIGUE PROBLEM. NO METHOD HAS YET BEEN FOUND FOR PREDICTING DESTRUCTIVE LIGHTING POLE VIBRATION. THESE CONDITIONS ARE UNIQUE AND CANNOT BE GUARANTEED AGAINST, AND ARE THE RESPONSIBILITY OF A LOCAL SITE ENGINEER.	
TITLE:	
CATALOG:	
DWG NO: STP-20-5211	SIZE: C SHEET 1 OF 1



POLE ORDERING GUIDE

ORDER NUMBER TEMPLATE

Example Order Number

Fixture			Catalog Number				Mounting Type	Fixture Mounting Arrangement	Finish	Options			Accessories		
Brand	Product	Number	Design	Mounting Height	Shaft Size	Wall Thickness				Design	Orientation	Height From Base	Design	Orientation	Height From Base
			STP	20	4	11	AB	T2	DB	WB-15	@90	10'	FH	@180	9'

Build Your Order Number

Fixture			Catalog Number				Mounting Type	Fixture Mounting Arrangement	Finish	Options			Accessories		
Brand	Product	Number	Design	Mounting Height	Shaft Size	Wall Thickness				Design	Orientation	Height From Base	Design	Orientation	Height From Base

Mounting Type

AB = Anchor Base
 EMB = Embedded (Direct Burial)

Fixture Mounting Arrangement

D1 D4
 D2@90 T2
 D2@180 T2.5
 D3@90 T3
 D3@120* T4

*Round poles only

Refer to the Mounting Orientation Guide on the next page of this file.

Finish

WH = White
 TWH = Textured White
 DB = Dark Bronze
 TMB = Textured Medium Bronze
 HB = Harvest Bronze
 NB = New Bronze
 SL = Silver
 MGY = Medium Gray
 GR = Gray
 TGR = Textured Gray
 GM = Graphite Metallic
 DP = Dark Platinum
 MA = Matte Aluminum
 PSP = Platinum Silver
 BK = Black
 TBK = Textured Black
 MG = Moss Green

Contact us for custom colors.

Options

CMB = Camera Mounting Bracket
 CMP = Camera Mounting Plate
 WB-15 = Welded Bracket
 WC = Welded Coupling (denote size)
 WN = Welded Nipple (denote size)
 Festoon = Festoon Provision
 CSBC = Custom Steel Base Cover
 VD = Vibration Dampener
 GFCI/IUC = Ground Fault Circuit Interrupter with In-Use Cover
 UL = UL Listed**

*See our online product catalog for complete catalog numbers of these options and accessories.

** UL Listed labeling is available for catalog steel and aluminum poles—both Commercial & Industrial and Roadway. UL Listed labeling is not available for brackets. UL Listing must be specified at the time of order.

Note: N/A = Not Applicable

Accessories

TB = Transformer Base*
 ABS-BC = ABS Base Cover*
 LW = Lowering Winch
 LW-ELECTRIC = Electric Lowering Winch
 BA = Banner Arm
 FH = Flag Holder
 PTTA = Pole Top Tenon Adapter*

Options

Custom Steel Base Cover

Design	Description
CSBC	Custom Steel Base Cover

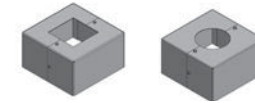

Vibration Dampener

Design	Description
VD	Recommended for use with all poles 25' and higher



*All vibration dampener are plus freight if purchased and shipped sperately.

Ground Fault Circuit Interrupter & In Use Cover

Design	Description
GFI	Weatherproof 15-20 amp. 125V A/C Recessed Ground Fault Circuit Interrupter with In Use Cover



Festoon - Switch or receptacle mounting provision

Design	Description
Festoon	Mounting provision for customer supplied switch or standard receptacle.

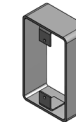

Mounting Bracket

Design	Description
CMB	Mounting Bracket
CMP	Mounting Plate



Welded Bracket

Design	Description
WB	2 3/8" OD Bent Slip-fit Pipe Bracket Welded on Pole



Welded Coupling

Design	Description
WC	Threaded Pipe Coupling with Wire Hole Welded to Pole



Welded Nipple

Design	Description
WN	Threaded Pipe Nipple with Wire Hole Welded to Pole



Shielded Circuit Provision

Design	Description
SCP	Shielded Circuit Mounting Provision



Extra Hand Hole

Design	Description
SCP	Shielded Circuit Mounting Provision



Fully Galvanized Anchor Bolts

Design	Description
FGAB	3/4" x 20"
	3/4" x 28"
	1" o.d.
	1.5" o.d.



Anchor Bolt Deduct — to be used when customer does not want anchor bolts shipped

Design	Description
L/AB	Deduct amount for all 3/4" anchor bolts (see pole type matrices for anchor bolt size)
	Deduct amount for all 1" anchor bolts (see pole type matrices for anchor bolt size)

UL or CSA Listing

Design	Description
UL	Poles can be ordered to meet UL requirements. "UL" must appear in the part number. UL Listed poles include a metal hand hole cover and UL label.
CSA	Poles can be ordered to meet CSA requirements. "CSA" must appear in the part number. CSA approved poles include required grounding provision and CSA label.



LUMINAIRE POLE WITH RESPECT TO ELECTRICAL HAZARDS ONLY <E473617>



CLASS - 3426 03 - LUMINAIRES - LUMINAIRE POLES

CATALOG NUMBER

YEAR OF MANUFACTURE

SUITABLE FOR WET LOCATIONS.

Accessories

Lowering Winch

Catalog Number	Description
LW	Lowering Winch for Hinged Steel Pole



Electric Lowering Winch

Catalog Number	Description
ELW	Electric Lowering Winch



Banner Arm

Catalog Number	Description
ELW	Electric Lowering Winch



Flag Holder

Catalog Number	Description
FH	Flag Holder



Flower Pot Holder

Catalog Number	Description
FPH	Flower Pot Holder



PTAR - Round Pole Top Tenon Adapters

Catalog Number	Drill Mount Options	Height (in.)	Pole Size (in. sq.)
PTAR-4RD-DXX	D1,D2,D3,D4	13	4
PTAR-5RD-DXX	D1,D2,D3,D4	13	5
PTAR-6RD-DXX	D1,D2,D3,D4	13	6



PTTA - Square Pole Top Tenon Adapters

Catalog Number	Drill Mount Options	Height (in.)	Pole Size (in. sq.)
PTTA-4SQ-DXX	D1,D2,D3,D4	13	4
PTTA-5SQ-DXX	D1,D2,D3,D4	13	5
PTTA-6SQ-DXX	D1,D2,D3,D4	13	6



ABS Composite Base Covers - 2 Piece

Catalog Number	Pole Shaft Size Dia. O.D. (in.)	Cover Dimension		Max Base Plate Size (in. sq.)
		SQ (in.)	Height (in.)	
3RD-ABS-BC	3 RD	9.88	5.25	9.00
4RD-ABS-BC	4 RD	9.88	5.25	9.00
5RD-ABS-BC	5 RD	11.38	6	10.63
5RD-T1-ABS-BC	5 RD	9.88	5.25	9.00
5 3/8RD-ABS-BC	5 3/8' RD	12.13	6	11.25
6RD-ABS-BC	6 RD	12.13	6	11.25
6 5/8RD-ABS-BC	6 5/8 RD	12.13	6	11.25
7RD-ABS-BC	7 RD	12.13	6	11.25
8RD-ABS-BC	8 RD	13.38	6	12.50
8.5RD-ABS-BC	8.5 RD	13.5	5.5	12.75
4SQ-ABS-BC	4 SQ	9.88	5.25	9.00
5SQ-ABS-BC	5 SQ	12.13	6	11.25
6SQ-ABS-BC	6 SQ	13.5	5.5	12.75

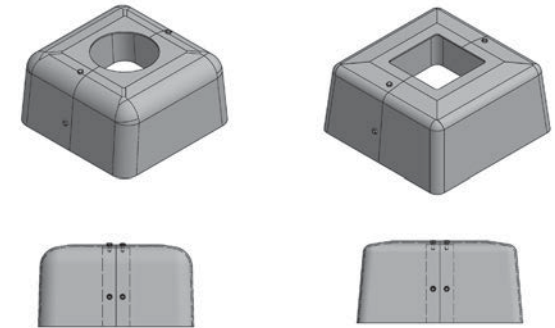

Two-Tier Adapter Plate*

Catalog Number	Min Bolt Circle (in.)	Max Bolt Circle (in.)	Included Base Cover
TTAP	-----	12	YES
TTAP-16	12	16	YES

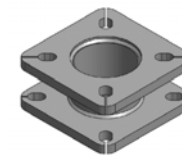

Pole Caps - Composite

Catalog Number	Pole Shaft O.D. Size (in.)
POLECAP-3RD	3.00
POLECAP-3.5RD	3.50
POLECAP-4RD	4.00
POLECAP-4.5RD	4.50
POLECAP-5RD	5.00
POLECAP-6RD	6.00
POLECAP-4SQ	4.00
POLECAP-5SQ	5.00
POLECAP-6SQ	6.00

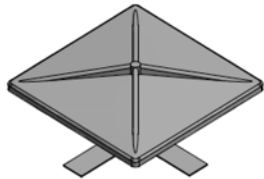

Hand Hole Covers*

Catalog Number	Size (in.)
HH-2X4-ASSY	2 X 4
HH-3X5-ASSY	3 X 5
HH-4X6-ASSY	4 X 6

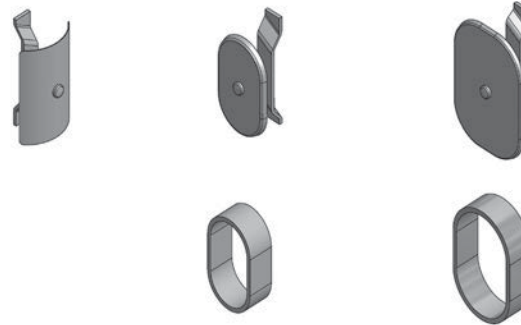

Break Away Couplings*

Catalog Number	To Fit Anchor Bolt Size (in.)
BAC-.75-SET	0.75 O.D.
BAC-1.0-SET	1.00 O.D.

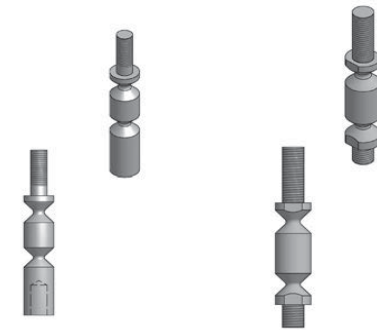

Transformer Bases

17" Transformer Base

Catalog Number	Top Bolt Circle (in.)	Bottom Bolt Circle (in.)	Height (in.)	Connecting Hardware Included
TB1-17	10.5 - 13.5	13 - 15	17.00	Yes
TB2-17	10 - 12	10 - 12	17.00	Yes
TB3-17	13 - 15.125	15 - 17.25	17.00	Yes

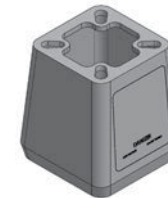

20" Transformer Base

Catalog Number	Top Bolt Circle (in.)	Bottom Bolt Circle (in.)	Height (in.)	Connecting Hardware Included
TB1-20	11 - 13	13 - 15	20.00	Yes
TB2-20	10 - 12	10 - 12	20.00	Yes
TB3-20	13 - 15.125	17.25	20.00	Yes

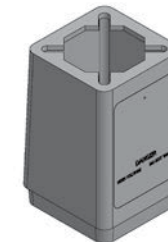

Standard Powder Coat Colors

Design	Color
WH	White
TWH	Textured White
DB	Dark Bronze
HB	Harvest Bronze
TMB	Textured Medium Bronze
NB	New Bronze
SL	Silver
MGY	Medium Gray
GR	Gray
TGR	Textured Gray
GM	Graphite Metallic
DP	Dark Platinum
MA	Matte Aluminum
PSP	Platinum Silver
BK	Black
TBK	Textured Black
MG	Moss Green

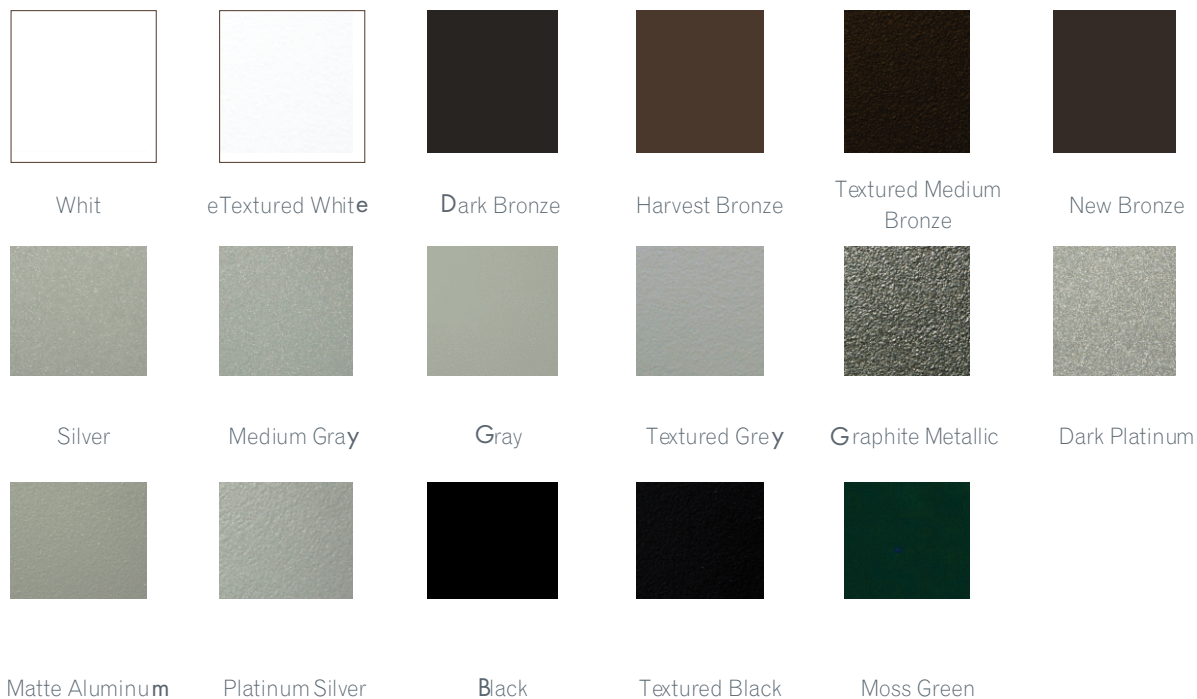

Touch-Up Paint

Design	Color
See Above	All Standard Colors Above Available

Additional cost for the above standard color finish or any other custom color. Contact our sales for more information.