

# GL2 Series

## LED GROW LIGHT

**Fixture Type:**

**Project Name**

**Location:**

**Date:**

### Features

The GL2 series LED grow light features a full-spectrum light, similar to the sun to provide high efficient lighting from seeding to harvest. It is an ideal choice for hobbyists and commercial growers. GL2 series is specially designed for commercial indoor horizontal and vertical growing environments, saving electric cost, releasing maximum PAR efficiency & uniform lighting distribution with great yield. The 3 times folding structure design makes the growing light more flexible, smallest package, and more simple to install, just plug and play. Single knob+RJ14 port for dimmer and timer. Multi-light connection with unified dimming is especially beneficial for large areas of indoor growing and commercial planting.

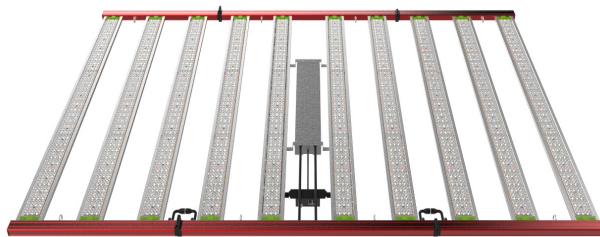

1000W

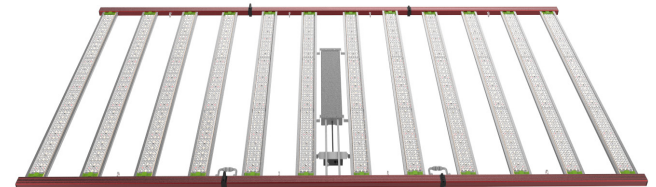

1200W

### Product Performance Standard

AC Input power	1000W/10 bars or 1200W/12bars	IP Rating	IP65
PPE	2.8 umol/J	Beam Angle	120 degree
PPF	2800 umol/s/3360umol/s	Mounting Height	6"-48"
Dimming	0-10V+RJ14 Controller	THD	<10%
Ratio	Full Spectrum;red white+IR	Warranty	5 Years
Input Voltage	120-277V/277-480V	Ambient Operation Temperature	-20C°~ 40C°

### Ordering Guide

Example: GL2-1000W

FIXTURE TYPE

WATTAGE



GL2

1000W

=1000Watts

1200W

=1200Watts



<b>Fixture Type:</b>
<b>Project Name</b>
<b>Location:</b>
<b>Date:</b>

## Photometry

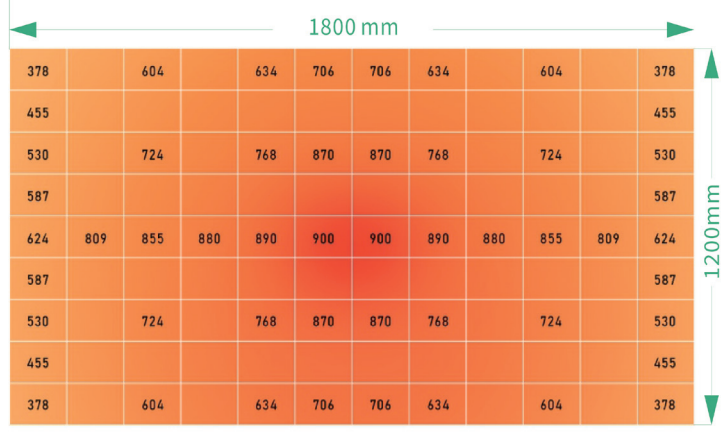
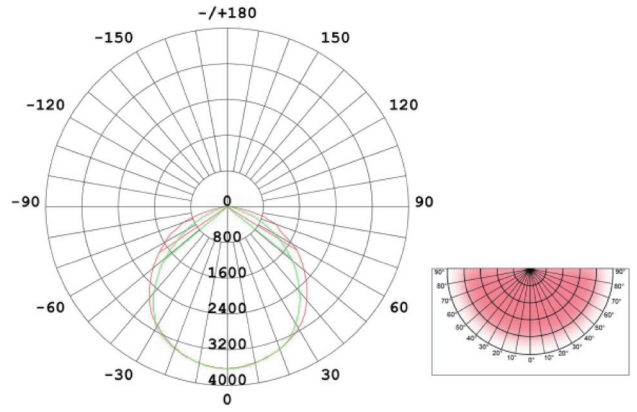

24" 2ft 60cm

## Dimensions

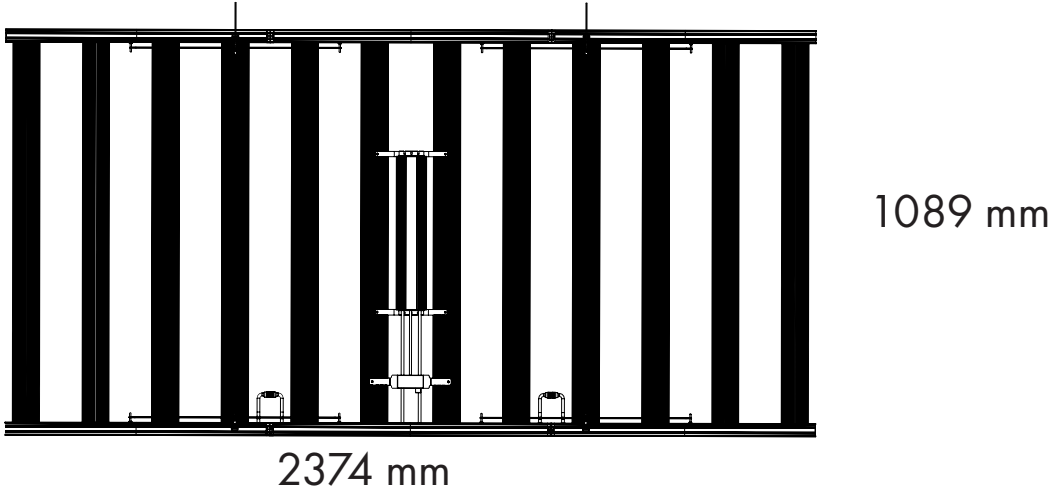
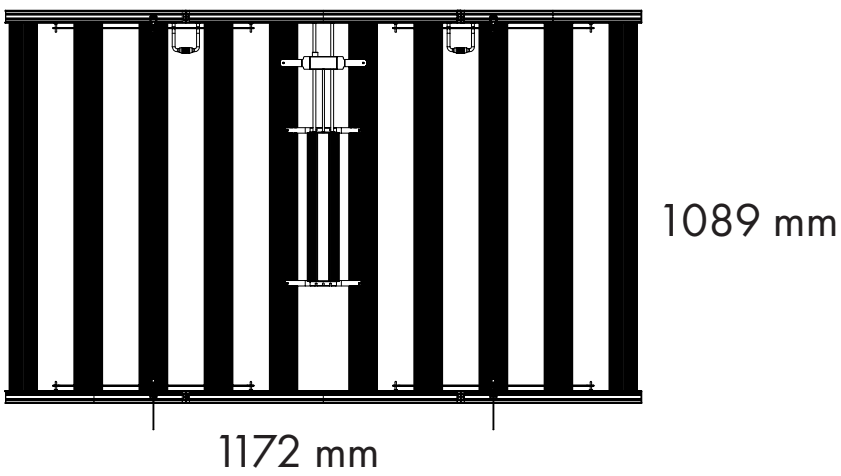

UNIT: mm

# GL2 Series

LED GROW LIGHT

<b>Fixture Type:</b>
<b>Project Name</b>
<b>Location:</b>
<b>Date:</b>

## Full Spectrum

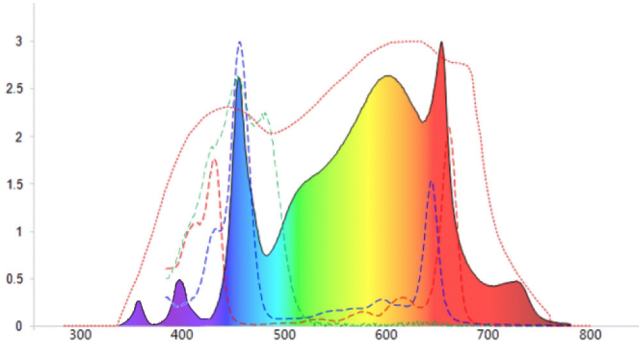

Full Spectrum

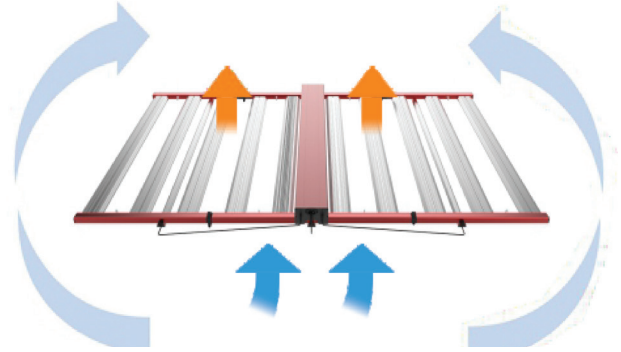

10-bar aluminum design for efficient heat dissipated

## Installation

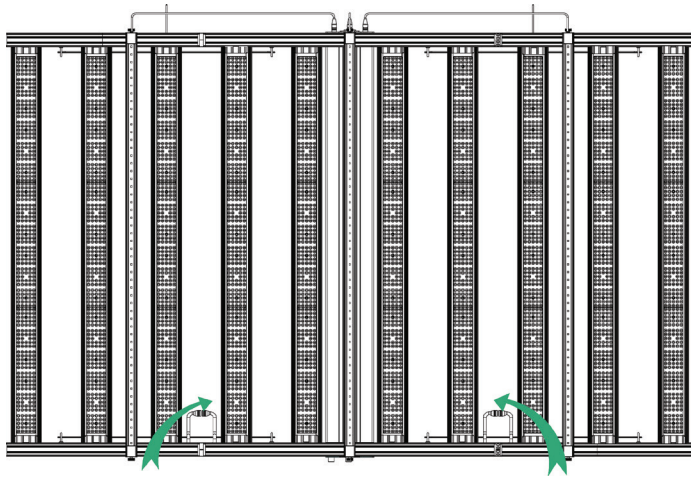

1. Unfold the light fixture.



1. Hang the light, plug and play.