

UHB3 Series

LED UFO HIGH BAY

Fixture Type:

Project Name

Location:

Date:

Features

- UHB3 is a compact and streamlined designed, which allows for efficient heat dissipation and better airflow.
- Durable die-cast aluminum housing with corrosion-resistant black powder coating which prolong the lifespan of the LEDs and ensure reliable performance over an extend period.
- Anti-UV prismatic translucent lens is specially designed to shape light uniformly and control glare.
- Wattage selectable provide flexibility in lighting design, allowing you to customize the illumination levels for different areas and tasks.
- 2CCT color temperature adjustable 4000K/5000K.
- Standard voltage 120-277V, optional Step down auto transformer allowing fixtures to be safely operated in 277-480V.
- Available for hook mount/pendant mount(3/4" conduit size)/surface mount.
- IP65 rating suitable for wet location.

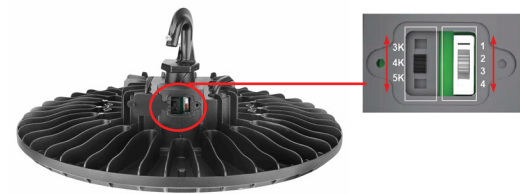

Easy to access the lumen output and color temperature switch on-site.



Dimensions

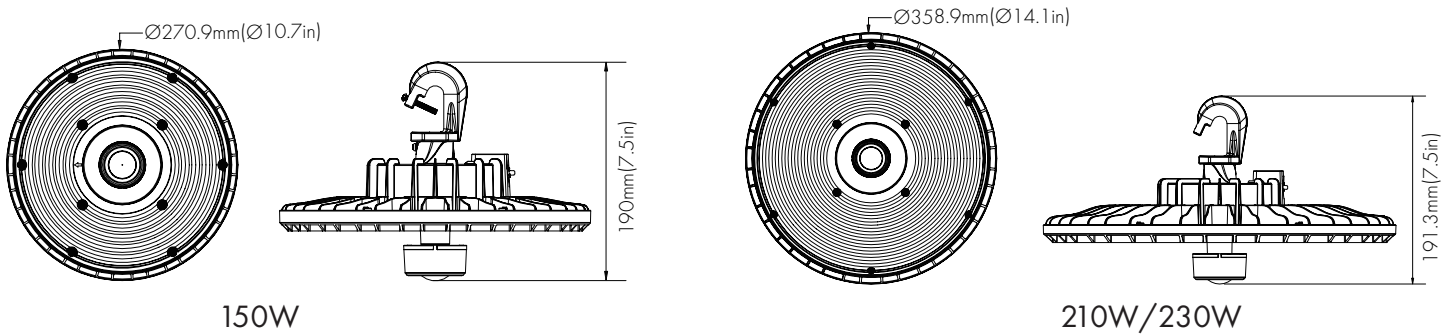

Specification

Material	Die cast aluminum housing with black powder coat finish	Efficacy	Over 150 lm/W
Lens	Anti-UV prismatic translucent lens	LED Life Span	50,000 hour LED lifespan based on TM-21 calculation
Beam angle	100 degree	Dimmable	0-10V Dimming
IColor Temp	2CCT 4000K/5000K	Lumen Package	10,800 lm to 36,000 lm
CRI	70	Warranty	5 Years
Input Voltage	Standard 120-277V Optional step down transformer use for 277-480V.	Ambient Operation Temperature	-40°C (-40°F) to 50°C (122°F)
Installation	Hook mount (default) Pendant mount(optional) Surface mount(optional)	Listing	DLC Premium UL Listed Wet location



UHB3 Series

LED UFO HIGH BAY

Fixture Type:
Project Name
Location:
Date:

Ordering Guide

Example: UHB3-UW2CCT-150W-HV-MS01-EM01-ALRFL150

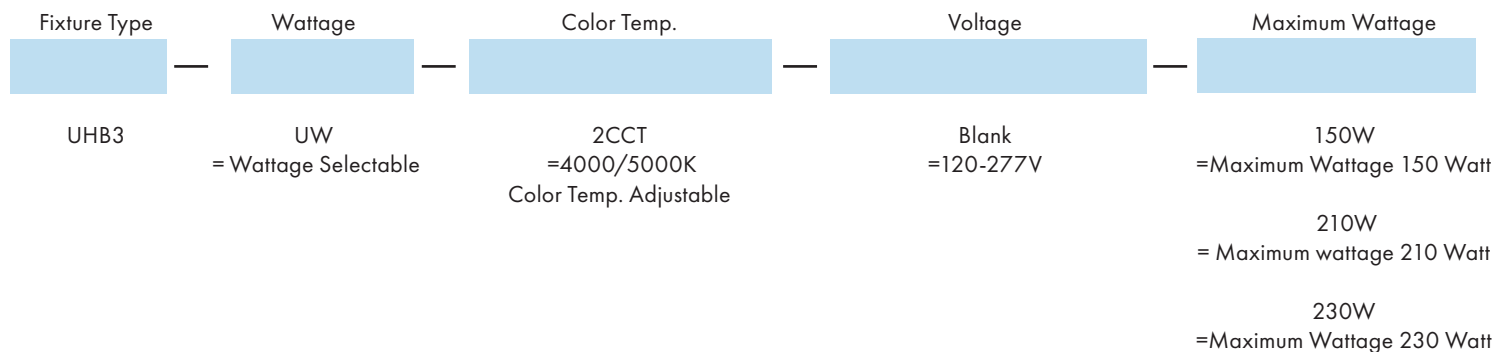

Optional Accessories

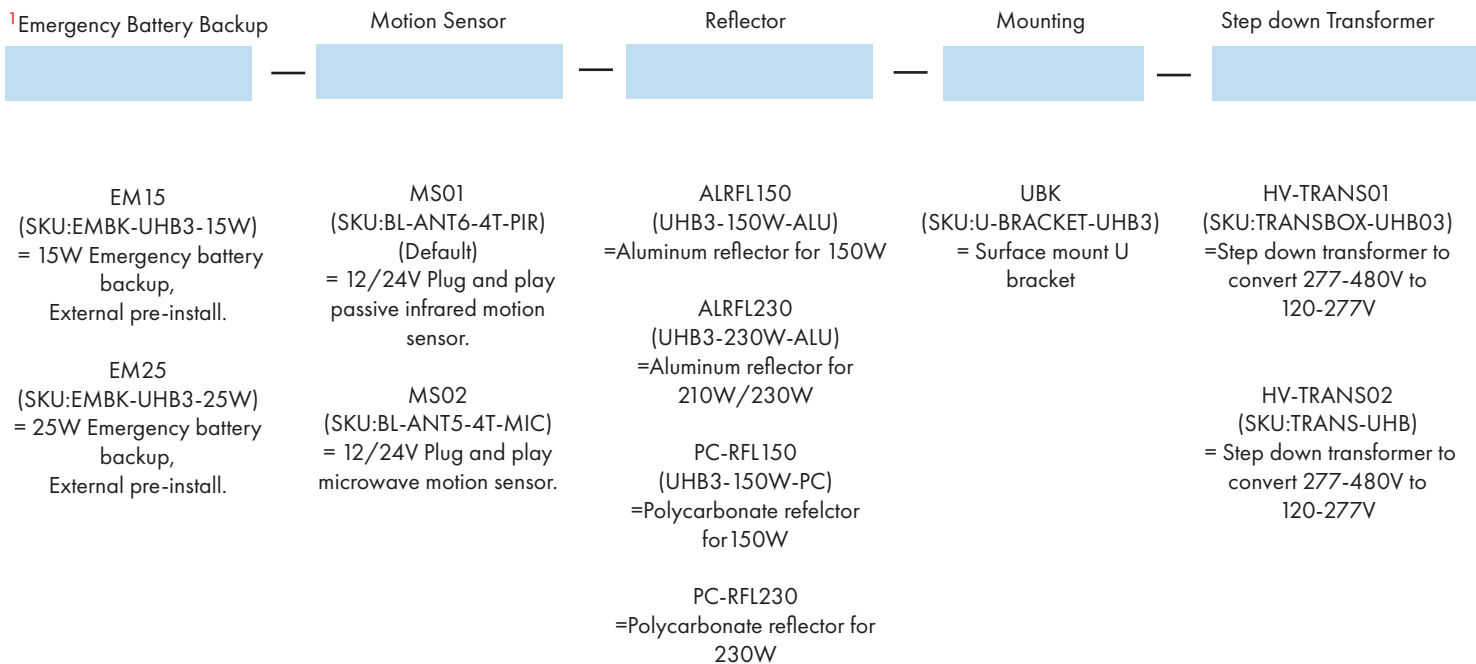

Note: 1. EM15 suitable for 150W, EM25 suitable for 210W and 230W.

2. U bracket is not support, when emergency battery backup is installed.



UHB3 Series

LED UFO High Bay

Fixture Type:

Project Name

Location:

Date:

Product Information

4000K			5000K		
WATTAGE	LUMEN	EFFICACY	LUMEN	EFFICACY	
230W	36000lm	157lm/W	35000lm	152lm/W	
184W	30000lm	163lm/W	29000lm	158lm/W	
138W	24000lm	174lm/W	23000lm	167lm/W	
92W	16500lm	179lm/W	16000lm	174lm/W	

4000K			5000K		
WATTAGE	LUMEN	EFFICACY	LUMEN	EFFICACY	
210W	30500lm	145lm/W	32000lm	152lm/W	
168W	25000lm	149lm/W	26500lm	158lm/W	
126W	20000lm	159lm/W	21000lm	167lm/W	
84W	14000lm	167lm/W	14500lm	173lm/W	

4000K			5000K		
WATTAGE	LUMEN	EFFICACY	LUMEN	EFFICACY	
150W	24000lm	160lm/W	22500lm	150lm/W	
120W	20000lm	167lm/W	19000lm	158lm/W	
90W	15500lm	172lm/W	14600lm	162lm/W	
60W	10800lm	180lm/W	10000lm	167lm/W	



UHB3 Series

LED UFO High Bay

Fixture Type:

Project Name

Location:

Date:

Optional Accessories



Plug and play PIR Motion Sensor

- SKU: BL-ANT6-4T-PIR

- 12/24V Passive infrared motion sensor plug and play motion sensor



Plug and play Microwave Motion Sensor

- SKU: BL-ANT5-4T-MIC

- 12/24V Microwave motion sensor plug and play motion sensor

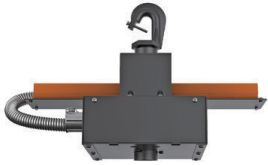

External Emergency Battery Backup

- SKU:EMBK-UHB3-15W (For UHB3-150W)

- External battery backup is pre-installed by factory.

- 90 minutes emergency operation, provide over 2,250 lm

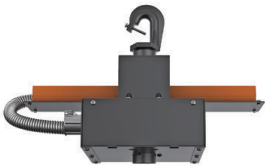

External Emergency Battery Backup

- SKU:EMBK-UHB3-25W (For UHB3-210W/230W)

- External battery backup is pre-installed by factory

- 90 minutes emergency operation, provide over 3,750 lm



Aluminum Reflector

- SKU: UHB3-150W-ALU / UHB3-230W-ALU

- Aluminum reflector



PC Reflector

- SKU: UHB3-150W-PC / UHB3-230W-PC

- PC reflector



U-Bracket

-SKU: U-BRACKET-UHB3

-Use for surface mount

UHB3 Series

LED UFO High Bay

Fixture Type:

Project Name

Location:

Date:

Optional Accessories



Step down transformer 01

- SKU: TRANSBOX-UHB3

- Step down auto transformer allowing fixtures to be safely operated in high voltage environments.

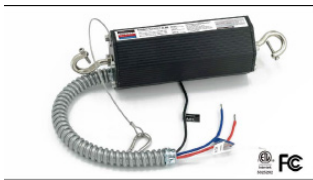

Step down transformer 02

- SKU: TRANS-UHB

- Step down auto transformer allowing fixtures to be safely operated in high voltage environments.

-480V to 208V or 347V to 150V or 277V to 120V

UHB3 Series

LED UFO High Bay

Fixture Type:
Project Name
Location:
Date:

Mounting



Hook mount (Default)

Pendant mount

Surface mount



Plug-and-Play Sensor (optional)
Sensor allows for security and energy saving.

Emergency Battery
25W 3500lm 90min

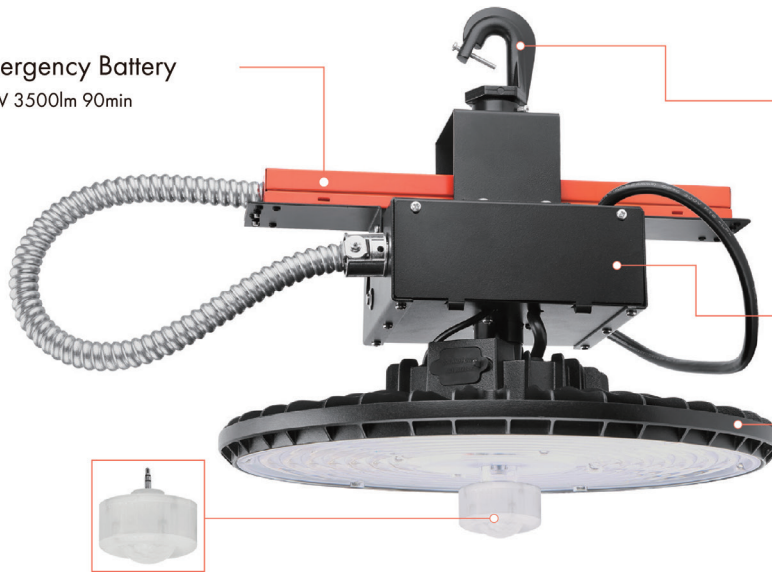

Installation accessory
Available for both hook mount, conduit mount and surface mounting with U-bracket(optional).
U-bracket allows to adjust the direction to illuminate any area you need.

Transformer BOX
Transformer can be easily added into the Junction-box and convert to HV models, reducing SKUs and inventory pressure.

Housing
Rugged die-cast housing with corrosion-resistant powder coating for effective protection.