

UPK1 Series

Wattage & CCT Adjustable Area Light

Fixture Type:

Project Name

Location:

Date:

Features

- Slim, low profile design minimized wind load requirements
- Wattage selectable 100%, 80%, 60%, 40%
- Adjustable color temperature 3000K/4000K/5000K
- Rugged die cast aluminum housing with weather-tight integral LED driver compartment
- Vibration rating of 3G or greater per ANSC136.31
- Estimated 100,000 hour LED lifespan based on IES LM-80 result and TM-21 calculations
- 3 Different optional distribution type III/IV/V
- Mounting option round pole/square pole, slipfitter, wall mount and yoke mount are available
- Optional accessories photocell and plug and play motion sensor
- 10 year warranty



Product Performance Standard

| | | | |
|----------------------|---------------------------|--------------------------------------|-------------------------------|
| Size | See dimension chart | Efficacy | Up to 167 lm/W |
| Weight | 12 lb/ 18lb | LED Life Span | 100,000 Hrs |
| IP Rate | IP65 | Dimmable | 0-10V Dimmable |
| Color Temp | 3CCT 3000K/4000K/5000K | THD | ≤20% |
| CRI | 70 | Distribution Type | Type III/IV/V |
| Input Voltage | 120-277V or 347-480V | Ambient Operation Temperature | -40C° (-40°F) ~45° (113°F) |

Dimensions

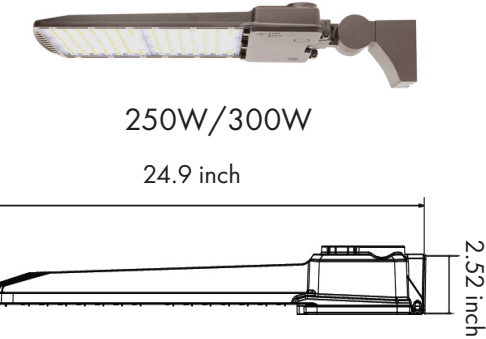
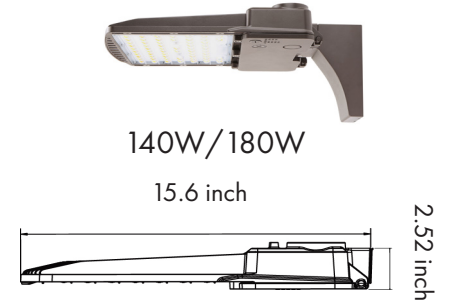

Ordering Guide Example: UPK1- UW3CCT - 300W-3-WM

| SKU | Wattage | Color Temp. | Voltage | Wattage Options | Optical | Finish ¹ | Mounting | Optional Accessories ² |
|------|---------------------|-------------------------|---------------|--------------------|------------|---------------------|-------------------------|---|
| UPK1 | UW | 3CCT | Blank | 140W | 3 | Blank | WM | Blank |
| | =Wattage selectable | = Color Temp adjustable | = 120-277V HV | =Max Wattage 140W | = Type III | = Dark Bronze | = Wall Mount | = No Accessories |
| | | 30/40/50K | = 347-480V | = Max Wattage 180W | = Type IV | = Black | = Arm mount | = Photocell (ALPC) HV Photocell(ALPC-HV) |
| | | | | 250W | 5 | WH ¹ | SP | MS ² |
| | | | | =Max Wattage 250W | = Type V | = White | = Slipfitter | = Motion Sensor |
| | | | | 300W | | | TM | (BL-ANT5-4T-PIR) |
| | | | | =Max Wattage 300W | | | = Trunnion Mount | |
| | | | | | | | JAM | |
| | | | | | | | = Adjustable Arm Mount | |
| | | | | | | | JWM | |
| | | | | | | | = Adjustable Wall Mount | |

Note: 1. Other finish color, consult factory for the availability
2. Motion sensor only available for low voltage fixture



UPK1 Series

Wattage & CCT Adjustable Area Light

Fixture Type:

Project Name

Location:

Date:

Product Information

| WATTAGE | 3000K | | 4000K | | 5000K | |
|---------|----------|----------|----------|----------|----------|----------|
| | LUMEN | EFFICACY | LUMEN | EFFICACY | LUMEN | EFFICACY |
| 60W | 9700 lm | 162 lm/W | 10600 lm | 177 lm/W | 10000 lm | 167 lm/W |
| 90W | 14000 lm | 156 lm/W | 15500 lm | 172 lm/W | 14500 lm | 161 lm/W |
| 120W | 18000 lm | 150 lm/W | 20000 lm | 167 lm/W | 18500 lm | 154 lm/W |
| 140W | 20000 lm | 143 lm/W | 23000 lm | 164 lm/W | 21000 lm | 150 lm/W |

| WATTAGE | 3000K | | 4000K | | 5000K | |
|---------|----------|----------|----------|----------|----------|----------|
| | LUMEN | EFFICACY | LUMEN | EFFICACY | LUMEN | EFFICACY |
| 72W | 11500 lm | 160 lm/W | 12500 lm | 174 lm/W | 12000 lm | 167 lm/W |
| 108W | 16000 lm | 148 lm/W | 18000 lm | 167 lm/W | 17000 lm | 157 lm/W |
| 144W | 20000 lm | 139 lm/W | 22500 lm | 156 lm/W | 21000 lm | 146 lm/W |
| 180W | 24000 lm | 133 lm/W | 27000 lm | 150 lm/W | 25000 lm | 139 lm/W |

| WATTAGE | 3000K | | 4000K | | 5000K | |
|---------|----------|----------|----------|----------|----------|----------|
| | LUMEN | EFFICACY | LUMEN | EFFICACY | LUMEN | EFFICACY |
| 100W | 15500 lm | 155 lm/W | 17000 lm | 170 lm/W | 16000 lm | 160 lm/W |
| 150W | 22000 lm | 147 lm/W | 24500 lm | 163 lm/W | 23000 lm | 153 lm/W |
| 200W | 28000 lm | 140 lm/W | 31000 lm | 155 lm/W | 29000 lm | 145 lm/W |
| 250W | 33500 lm | 134 lm/W | 37000 lm | 148 lm/W | 34500 lm | 138 lm/W |

| WATTAGE | 3000K | | 4000K | | 5000K | |
|---------|----------|----------|----------|----------|----------|----------|
| | LUMEN | EFFICACY | LUMEN | EFFICACY | LUMEN | EFFICACY |
| 120W | 19200 lm | 160 lm/W | 21500 lm | 179 lm/W | 20000 lm | 167 lm/W |
| 180W | 28000 lm | 156 lm/W | 30000 lm | 167 lm/W | 28500 lm | 158 lm/W |
| 240W | 35000 lm | 146 lm/W | 38500 lm | 160 lm/W | 36000 lm | 150 lm/W |
| 300W | 41000 lm | 137 lm/W | 45000 lm | 150 lm/W | 42000 lm | 140 lm/W |



UPK1 Series

Wattage & CCT Adjustable Area Light



Fixture Type:

Project Name

Location:

Date:

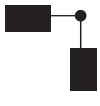
EPA OF AREA LIGHT

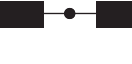
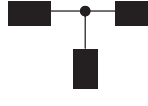
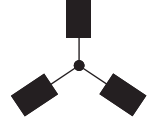
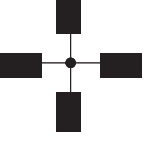
| Item |  |  |  |  |  |  |  |
|-----------|---|---|---|---|--|---|---|
| | 1 | 2 @90° | 2 @120° | 2@180° | 3 @90° | 3 @120° | 4 @90° |
| 140W/180W | 0.3632 | 0.6849 | 0.8861 | 0.7264 | 1.0481 | 1.2078 | 1.0481 |
| 250W/300W | 0.4758 | 0.8091 | 1.059 | 0.9516 | 1.2849 | 1.3923 | 1.2849 |

| WATTAGE | DIST.TYPE | B | U | G |
|---------|-----------|---|---|---|
| 140W | 3 | 3 | 0 | 3 |
| 180W | 3 | 3 | 0 | 3 |
| 250W | 3 | 4 | 0 | 4 |
| 300W | 3 | 4 | 0 | 4 |

Optional Accessories



Photocell

- SKU: ALPC/ALPC-HV
- External Photocell is field installed or pre-installed by request



Plug and play motion sensor

- SKU: BL-ANT5-4T-PIR
- PIR motion sensor allows for security and energy saving.



Glare Shield

- SKU: UPK-Glare Shield



Multi Direction Mount (For wall mount & arm mount use only)

- SKU: UNVMPK
- Adjustable universal mount allow custom beam direction.

UPK1 Series

Wattage & CCT Adjustable Area Light

| |
|----------------------|
| Fixture Type: |
| Project Name |
| Location: |
| Date: |

Mounting Options



Arm Mount
(4" and 5" Square and Round poles)
Standard versatile mounting arm is simple to install and can be used with existing poles for retrofit installations.



Slipfitter Mount
An optional cast aluminum mast arm adapter secures fixture head to nominal 2-3/8" O.D. horizontal steel tenon arm.



Wall Mount
Wall Mount is easy to install for direct wall mounting with 1/2' conduit wiring or standard J-box mounting



Yoke Mount
Die-cast aluminum trunnion is easily adapted to many surfaces and allows easy fixture aiming angles.



Adjustable Arm/Wall Mount
Standard versatile mounting arm is simple to install and can be used with existing poles for retrofit installations.

Distribution Type

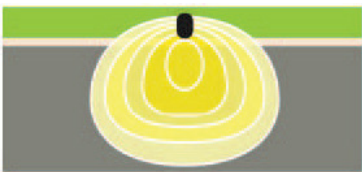

Type3 - Optics produce an asymmetrical pattern that directs the majority of the light forward and equally on both sides of the luminaire. In a back to back configuration, it creates a rectangular pattern which can extend pole spacing.

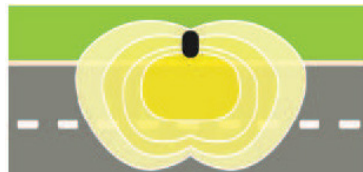

Type4 - Suitable for applications where light is primarily required forward with minimal back light. Typical installations include perimeter poles

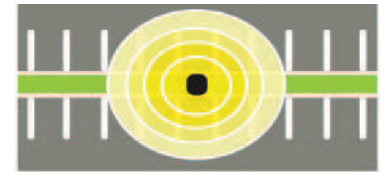

Type5 - Optics produce a symmetrical square distribution pattern that distributes light equally on all sides of the luminaire.