

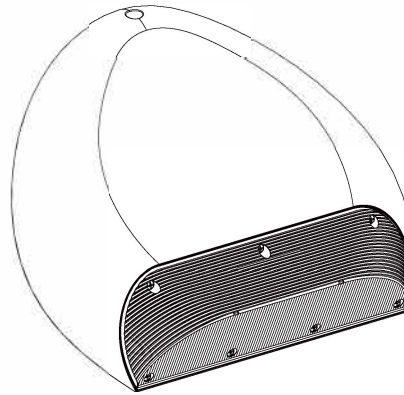

## Instrucciones de instalación



Lista de empaquetado		
	Prensaestopas 1/2-14NPS	1 PC
	Tornillo M5x45	4 PCS
	Anclaje de plástico acanalado 8x4	4 PCS



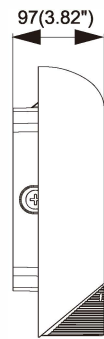
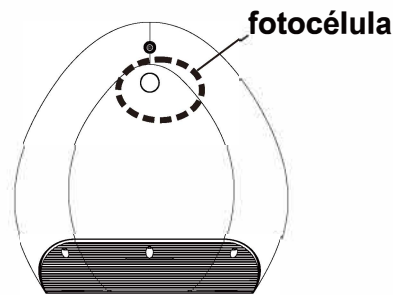
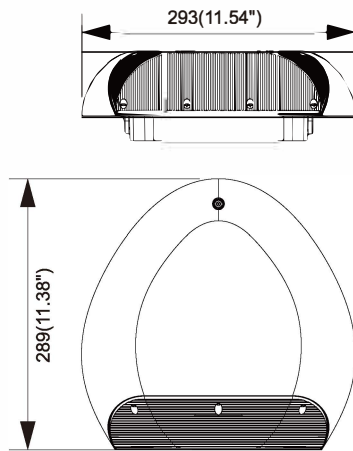

## Dimensiones físicas (mm/pulgadas)

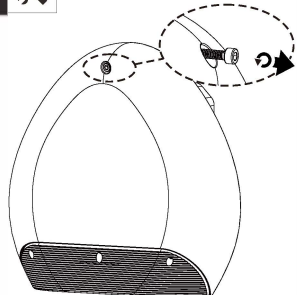

15W/25W/35W/45W/55W

**1.** 



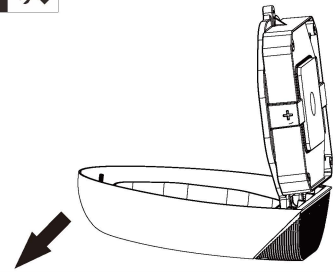

 2 Nm  
 M5x40

**2.** 



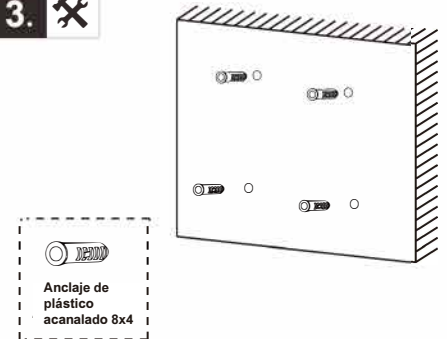

**3.** 

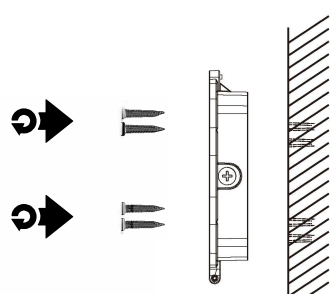

 Anclaje de plástico acanalado 8x4

**4.** 



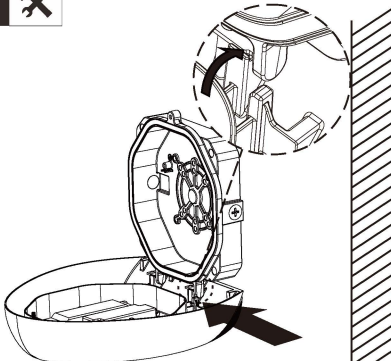

 1.2 Nm  
 Tornillo M5x45

**5.** 

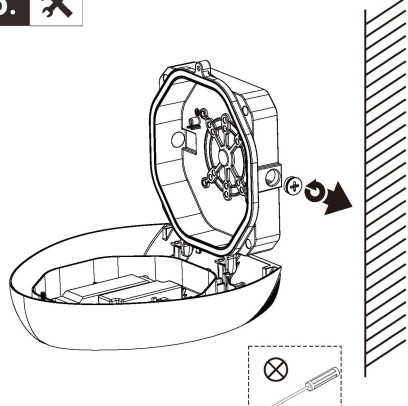

**6.** 





## 7. Instrucciones para luminaria de emergencia de potencia y CCT seleccionables

### A. Entrada lado cable

Por favor, seleccione una potencia adecuada y CCT por el interruptor antes instalaion.

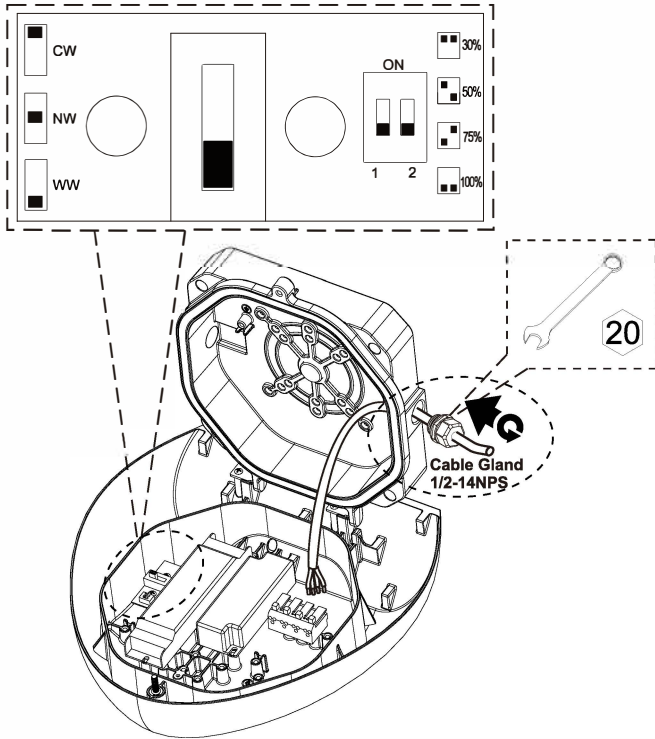

### B. Cable Entrada trasera

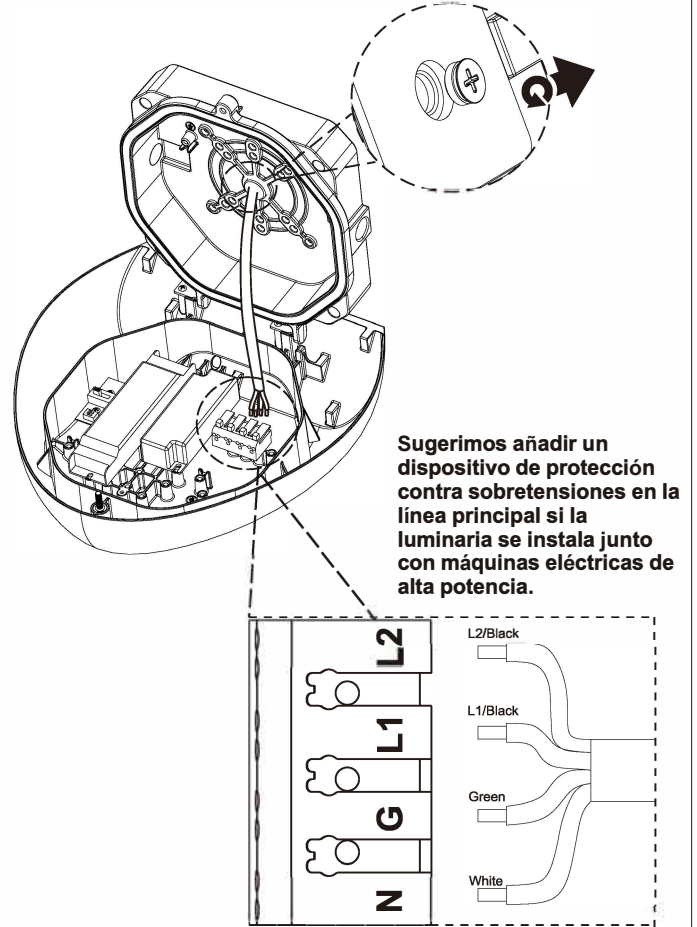

 **Advertencia:** no conecte el cable de atenuación a un voltaje alto, si lo tiene, o la función de atenuación fallará.

### 8.

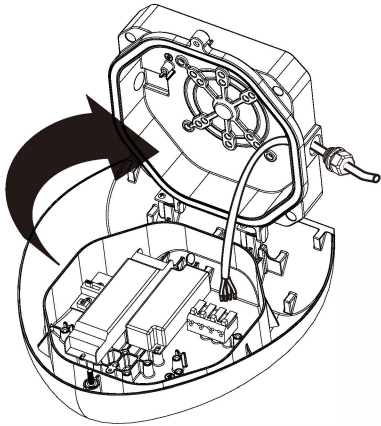

### 9.

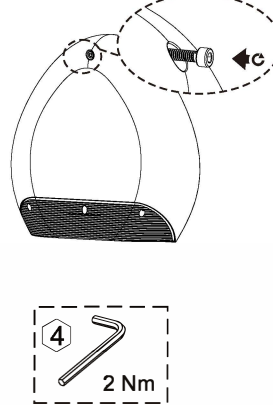

### 10.

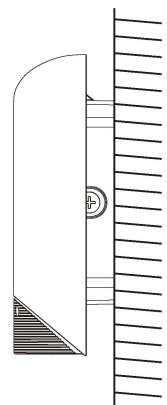

**Sólo debe instalarse fuera del alcance de la mano**

Especificaciones del producto	15W	25W	35W	45W	55W
Tensión de entrada	100-277 VAC				
frecuencia eléctrica	50 / 60 Hz				
Dimensiones de las perspectivas	293x289x97mm(15.54"x11.38"x3.82")				
Peso neto de la luminaria	2.7±0.3KG(5.95±0.66Lbs)				
temperatura de trabajo	0°C to + 40°C(32°F to +104°F)				
temperatura de almacenamiento	-40°C to +70°C(-40°F to +158°F)				

• La fuente luminosa contenida en esta luminaria sólo podrá ser sustituida por el fabricante o su agente de servicio o una persona cualificada similar.