

2CD Series JBox Split Downlight

Fixture Type:

Project Name:

Location:

Date:

Features

- CCT adjustable option by dip switch (3000K/3500K/4000K)
- Wattage selectable option 27W/34W/40W
- Split design of LED light engine and trim, one engine allows for seamless integration fo multiple trim option
- White aluminum trim available in 4",6",8",10" with round,square and wall wash trim type option.
- Simple installation with spring action housing clips integrated J-box for direct wire eliminated recessed can



Dimension

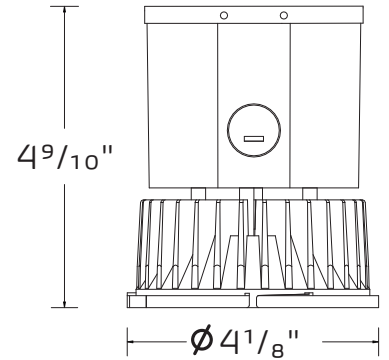

20W IC, 40W NON IC



Product Performance Standard

Size	3 1/2" L X Ø4 1/8"	Power Factor	≥90%
Weight	4 lb	LED lifespan	50,000 Hrs
Mounting	Recessed	Dimmable	1-10V Dimmable
Color Temp	3CCT/Single Color Temp.	Energy Star	YES
CRI	80	Warranty	5 Years
Input Voltage	120-277V	Ambient Operation Temperature	0C° (32°F) ~40C°(104°F)

Ordering Guide

Example: LED2CD 20W35K

Fixture Type	Wattage	Color Temp.	Voltage	Trim Size	Add-on Accessories
LED2CD	20W UW = 27W/34W/40W (Wattage Selectable)	UT (30K/35K/40K) (Color Temp. Switchable) 30K=3000K 35K=3500K 40K=4000K	Blank = 110-277V HV = 110-347V	4RT=4" Round Trim 6RT=6" Round Trim 8RT=8" Round Trim 10RT=10" Round Trim 4ST=4" Square Trim 6ST=6" Square Trim 4RWT=4" Wall Wash Round Trim 6RWT=6" Wall Wash Round Trim 4SWT=4" Wall Wash Square Trim 6SWT=6" Wall Wash Square Trim	Blank = No Accessories EM = Emergency Battery Backup (A-EMBK8VLV-EXT) NCF=New construction frame Kit

Fixture Type:
Project Name:
Location:
Date:

Product Information

3000K			3500K		4000K	
WATTAGE	LUMEN	EFFICACY	LUMEN	EFFICACY	LUMEN	EFFICACY
20W	1600lm	80lm/W	1600lm	80lm/W	1600lm	80lm/W
27W	2160lm	80lm/W	2160lm	80lm/W	2160lm	80lm/W
34W	2550lm	80lm/W	2550lm	80lm/W	2550lm	80lm/W
40W	3000lm	80lm/W	3000lm	80lm/W	3000lm	80lm/W

Optional Accessories



External Emergency Battery Backup

SKU: F2EMBK8W170V-EXT

- External Emergency battery backup
- Delivery up to 640 lumen for 90 min emergency use



New construction frame

- SKU: CDFRAME-3/4/6
- New construction frame 3"/4"/6"

Fixture Type:

Project Name:

Location:

Date:

Optional Trim



4"Round Trim

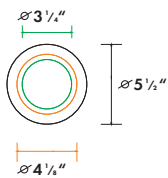

6"Round Trim

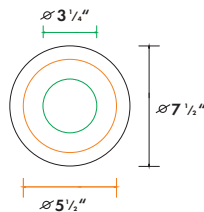

8"Round Trim

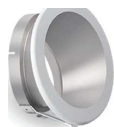
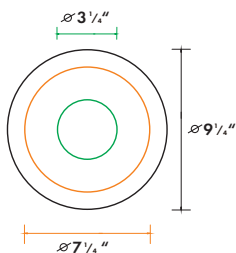

4"Round Wall Washer

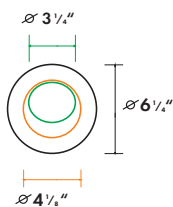

6"Round Wall Washer

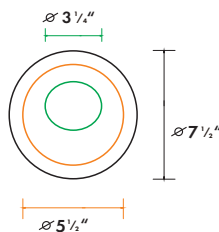

4"Square Wall

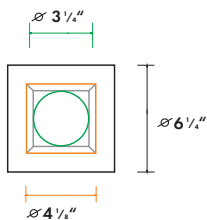

6"Square Wall

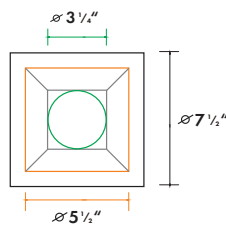

4"Square Wall Washer

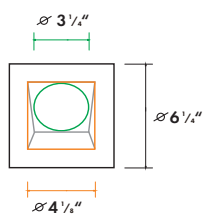

6"Square Wall Washer

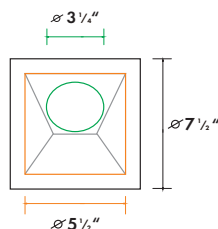

Fixture Type:

Project Name:

Location:

Date:

Wiring Diagram

CORD/ SUPPLY WIRING

LUMINAIRE

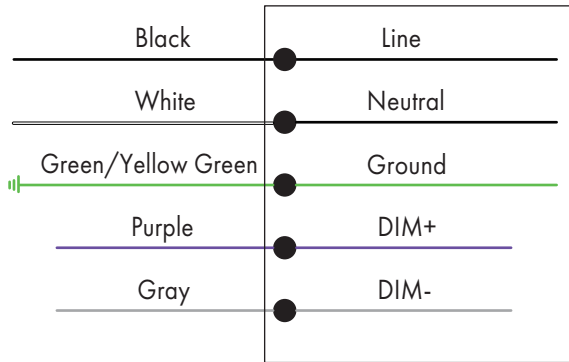

Scan the QR code or visit
www.lironlighting.com/products/led2cd
 for the complete luminaire installation guide.

Note:
