

Fixture Type:

Project Name:

Location:

Date:

Features

- Rugged die cast aluminum housing
- Dark bronze powder coat finish
- Polycarbonate optical lens with UV stabilizer
- Full cutoff with zero uplight and low glare at angles
- J box or surface mounting
- Compatible with photocell and emergency battery
- Premium DLC 5.1



Dimension

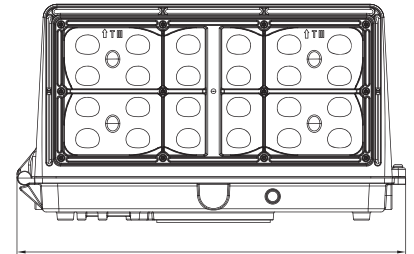
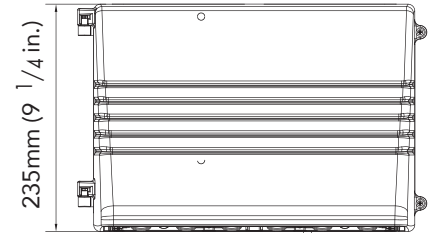

361mm (14 1/4 in.)

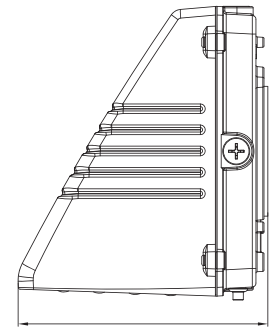

203mm (8 in.)



Product Performance Standard

Size	14 1/4" L x 8" W x 9 1/4" H	Power Factor	≥90%
Weight	7 lb	LED Lifespan	50,000 Hrs
IP Rate	IP65	Dimmable	Non Dimmable
Color Temp	4000K-5000K	DLC	YES
CRI	70	Warranty	10 Years
Input Voltage	120-277V	Ambient Operation Temperature	-40C° (-40°F) ~45C° (113°F)

Ordering Guide Example: LEDFCUWP27W40K

Fixture Type	Wattage	Color Temp.	Voltage	Finish	² Optional Accessories
LEDFCUWP	1.27W 70W	40K=4000K 50K=5000K	Blank = 120-277V	Standard finish: Blank = Dark Bronze ³ Premium finish: BK = Black WH = White	Blank = No Accessories PC = Photocell (-WPPC) EM = Emergency Battery Backup (EMBK8WH-A-INT01)

Note: 1.27W is only compatible with 120-277V input
 2.Photocell and emergency battery is not available for high voltage fixture
 3.Premium finish incur on additional cost, contact factory for MOQ and availability.

Fixture Type:

Project Name:

Location:

Date:

Product Information

4000K			5000K	
WATTAGE	LUMEN	EFFICACY	LUMEN	EFFICACY
27W	3900lm	144lm/W	3950lm	146lm/W
70W	9800lm	140lm/W	9750lm	139lm/W

Optional Accessories



Internal Photocell

-SKU: WPPC

-Internal photocell is field installed or pre-installed by request.



Internal Emergency Battery Backup

-SKU: EMBK8WH-A-INT01

-Internal battery backup is field installed or pre-installed by request.

-1000 lumen 90min for emergency use.

For the accessories detail, please visit www.lironlighting.com/product_categories/add-on-accessories

Fixture Type:

Project Name:

Location:

Date:

Installation Guide

1. Junction box Mounting

1. Loosen screws and remove the front case set carefully from the back plate.
(Angle between front case and back plate varies from 0 degree to 45 degree.
Push up to take down the front case.)
2. Remove 1/2" plug in center (B) for wiring, the fixture supports standard 3 1/4" and 4" Junction box.
3. Attach the back plate on the wall, use the supplied gaskets for a weather tight seal.
4. Finish wiring (Black for Line, White for Neutral and Yellow Green for Ground).
5. Replace the lens set on the hinges, make connections and close the lens set then tighten the screws.

2. Conduit Mounting

1. Loosen screws and remove the front case set carefully from the back plate.
(Angle between front case and back plate varies from 0 degree to 45 degree.
Push up to take down the front case.)
2. Remove 1/2" plug from where you intend to feed conduit .
3. Drilling out the holes (C) to secure it on the wall with choosing proper screws.
4. Finish wiring (Black for line, white for Neutral and Yellow-Green for Ground).
5. Replace the lens set on the hinges, make connections and close the lens set then tighten the screws.

3. Outdoor Flush Mounting

1. Loosen screws and remove the front lens set carefully from the back plate.
2. B Hole 1/2" dia. Screw the hole where you intend to connect the wire from the wall.
3. Drilling out the holes (C) to secure it on the wall by choosing the proper screws.
4. Finish wiring (Black for line, white for Neutral and Yellow-Green for Ground)
5. Replace the lens set on the hinges, make connections and close the lens set then tighten the screws.

Note: To ensure waterproofing seal, apply weatherproof silicone sealant around the edge of the wall mounting box and junction box. This is especially important with an uneven wall surface. Silicone all plugs and unused conduit entries

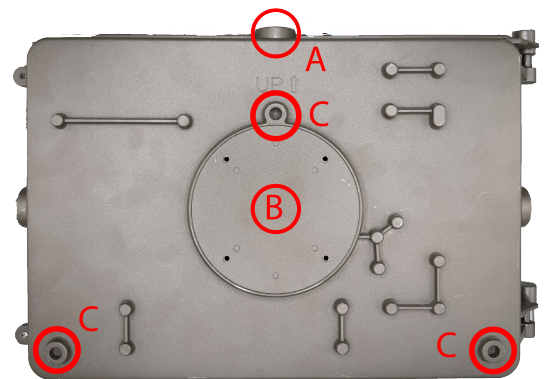
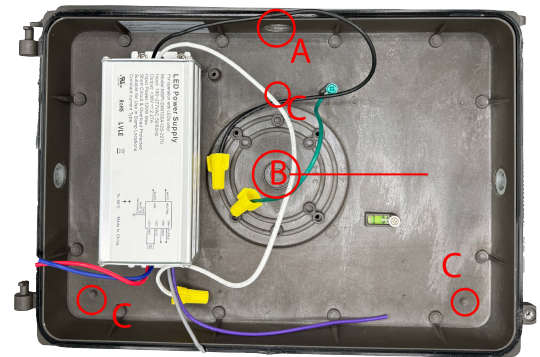
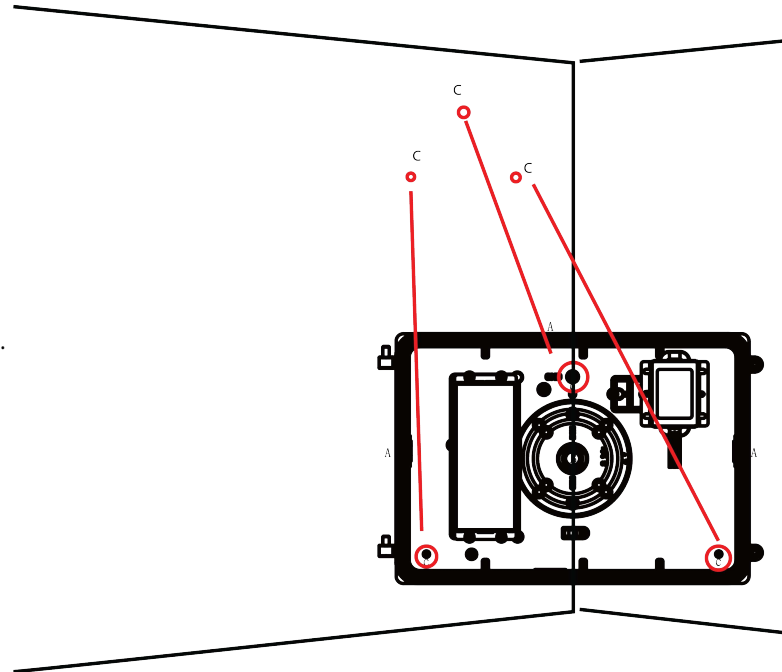

Fixture Type:

Project Name:

Location:

Date:

Wiring Diagram

CORD/ SUPPLY WIRING

LUMINAIRE

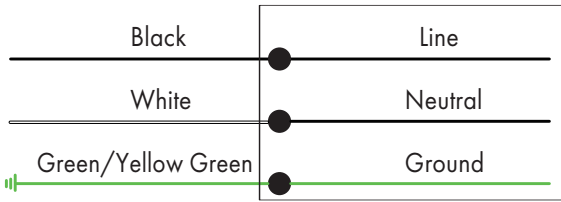

Scan the QR code or visit www.lironlighting.com/products/ledfcuwp for the complete luminaire installation guide.

Note:
